

For reference only. See data sheet for the detailed specifications.

## Technical Specification



Frequency Range(GHz)	10.0 - 110.0
Gain(dBi)	13 Typ.
Polarization	Linear
3dB Beamwidth(deg)	E Plane: 104 - 11
	H Plane: 78 - 9
Cross Pol. Isolation(dB)	30 Typ.
VSWR	1.5:1 Typ.
	2.5:1 Max.
Connector	1.0mm-Female
Power Handling(W CW)	4 Max.
Material	Al
Finish	Gold Plated and Chemical Conversion Coating
Size(mm)	41.3 x 41.3 x 65
Net Weight(Kg)	0.10 Around

PATENT ID (US)

US 11442093, US D978843

PATENT ID (China)

ZL202020182917.9, ZL202030087711.3

## Outline Drawing (Size: mm)

1.0mm-Female Output (P/N: LB-1001100-1.0F)

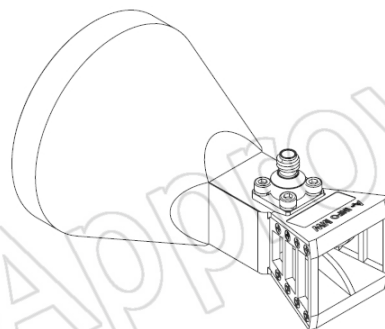
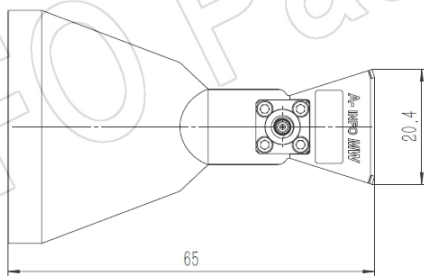
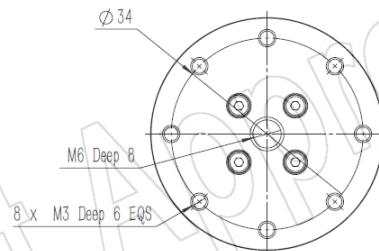
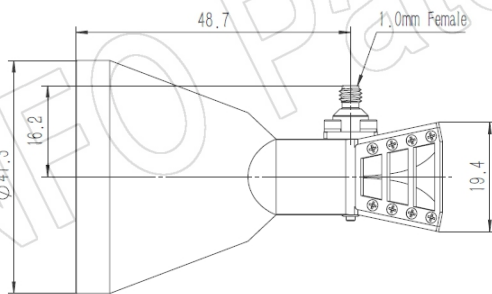

AINFO Inc.

China(Beijing):  
China(Chengdu):  
USA :

Tel: (+86) 10-6266-7326,  
Tel: (+86) 28-8519-2786,  
Tel: (+1) 949-639-9688,

(+86) 10-6266-7327  
(+86) 28-8519-3044  
(+1) 949-639-9608

Fax: (+86) 10-6266-7379  
Fax: (+86) 28-8519-3068  
Fax: (+1) 949-639-9670

Website: [www.ainfoinc.com](http://www.ainfoinc.com)  
Email: [sales@ainfoinc.com](mailto:sales@ainfoinc.com)

## Test Results

### 1. Gain Antenna Factor

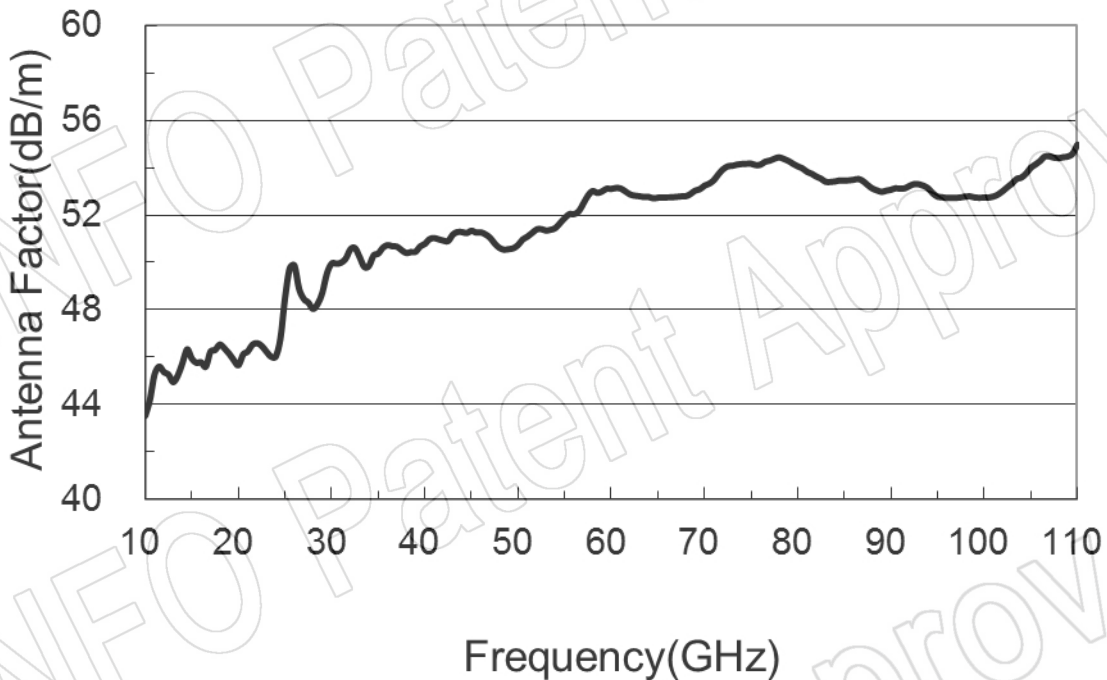
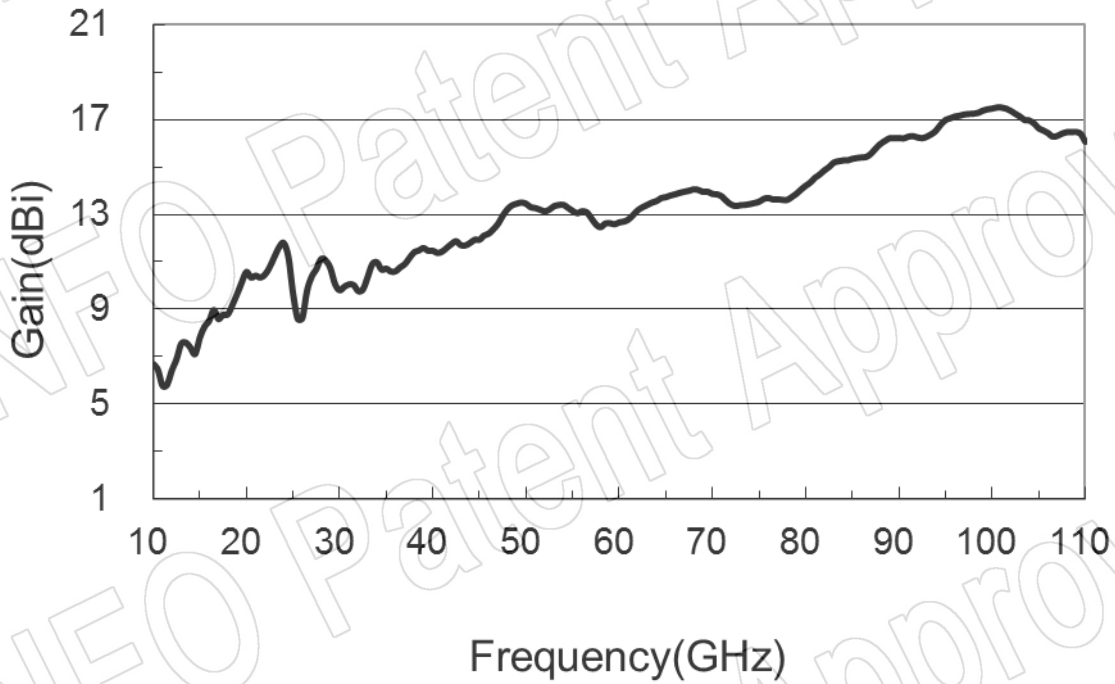

## 2. VSWR

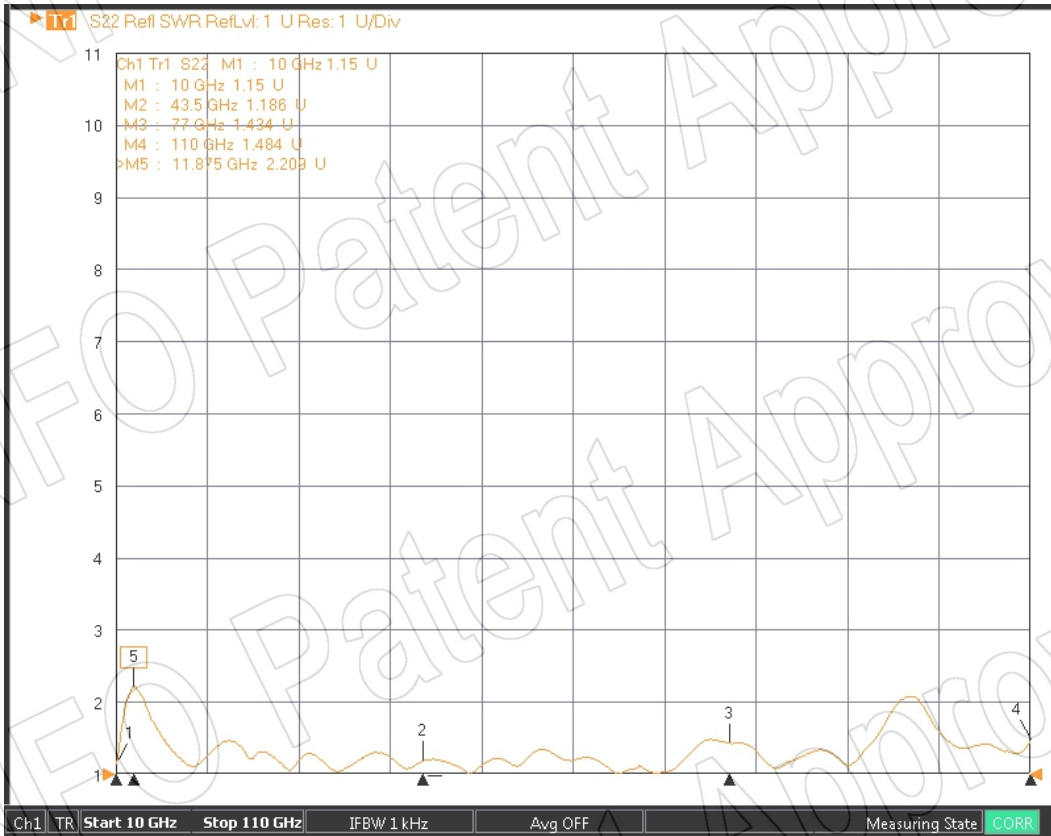

## 3. Pattern

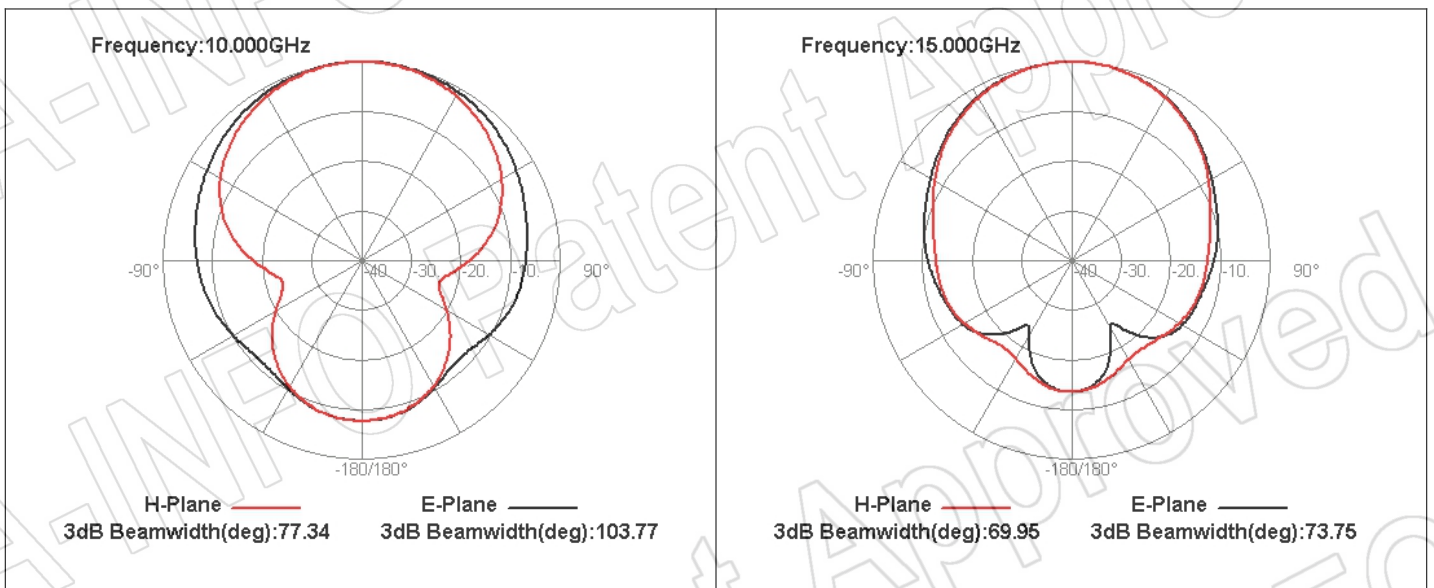

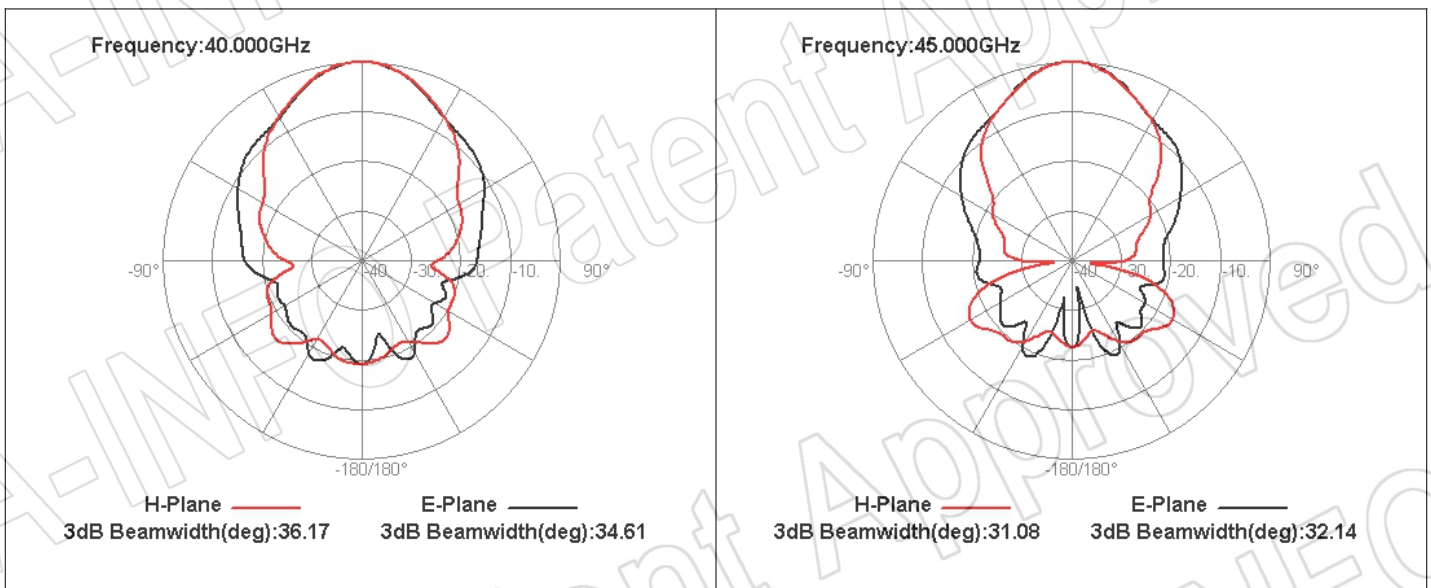
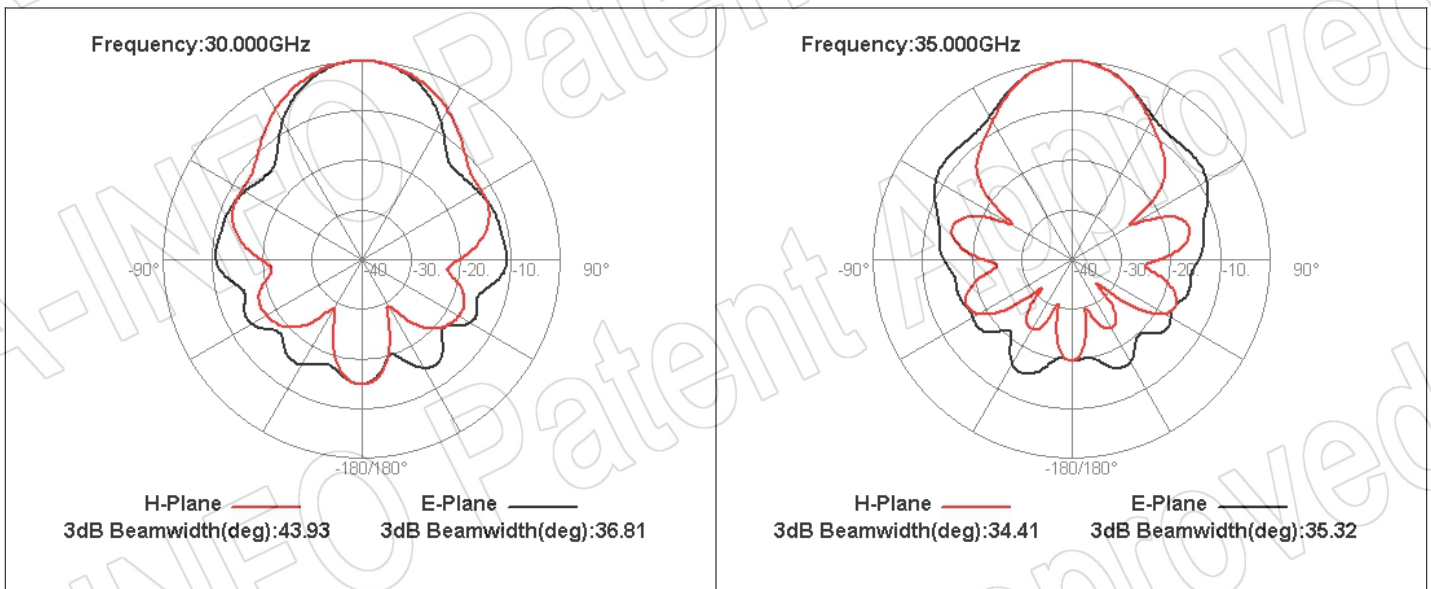
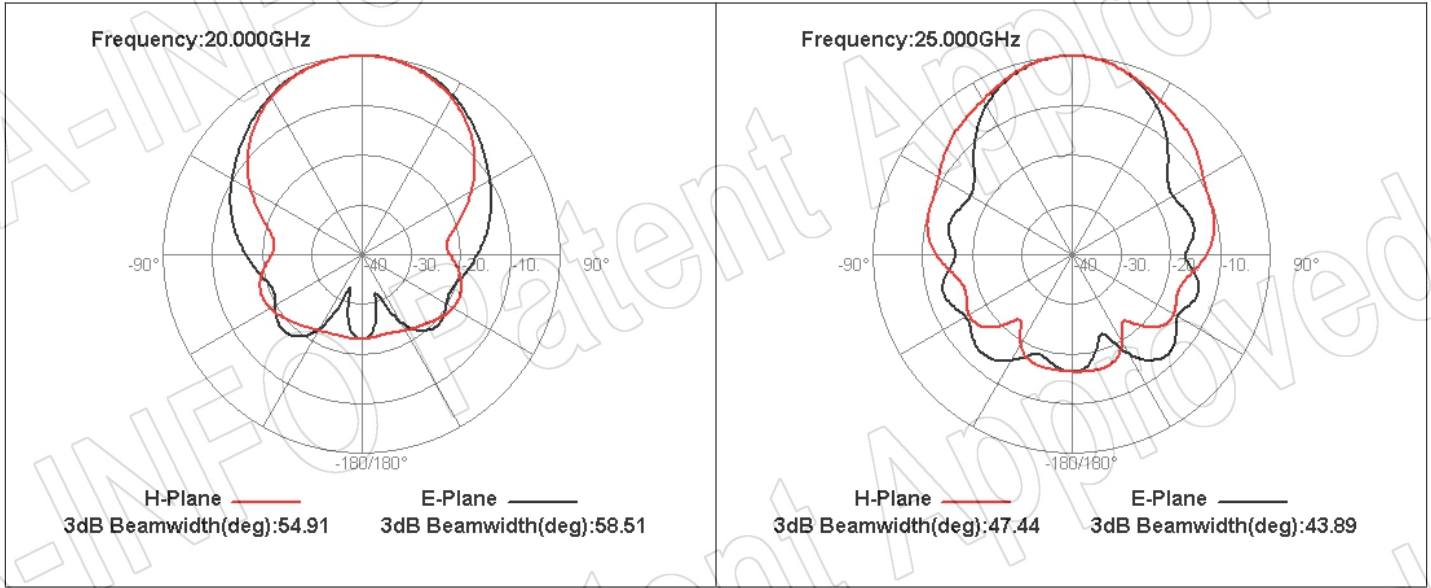

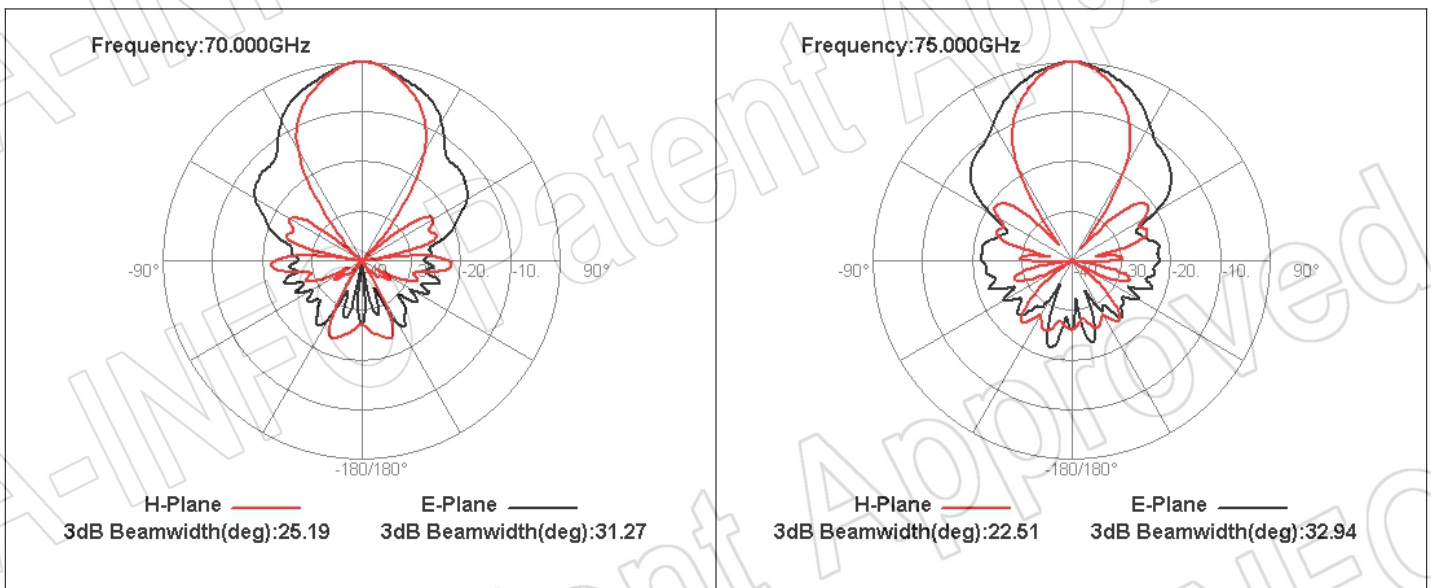
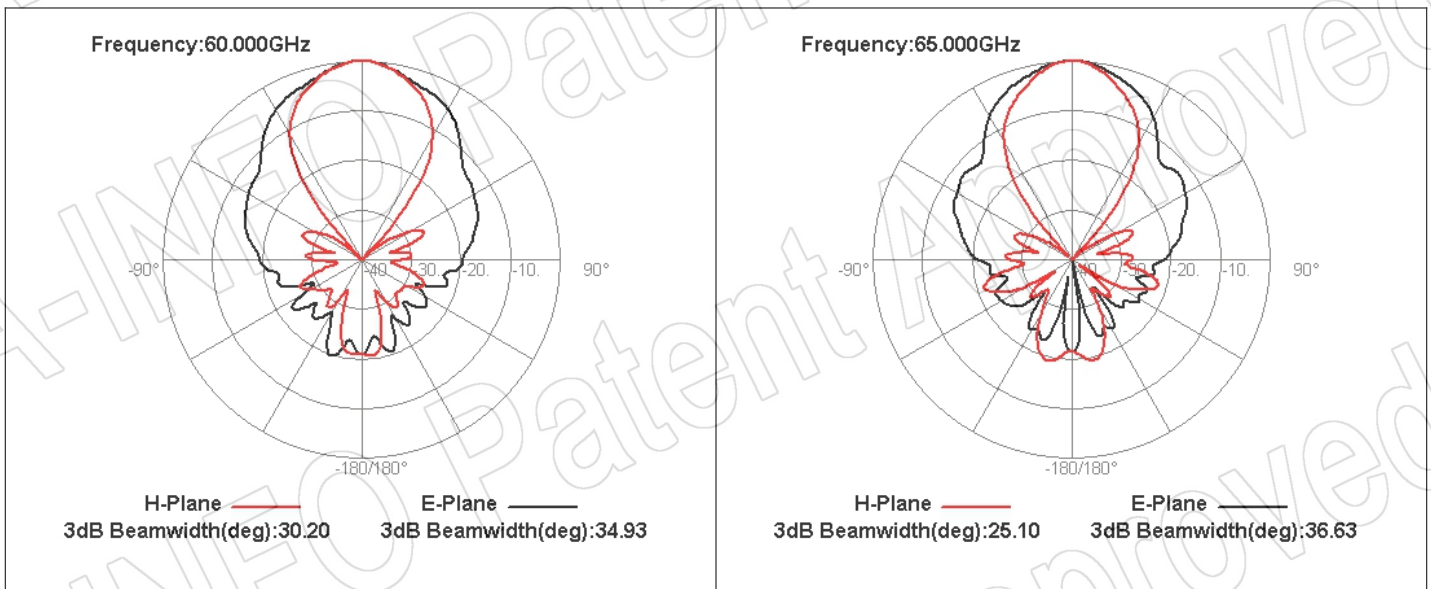
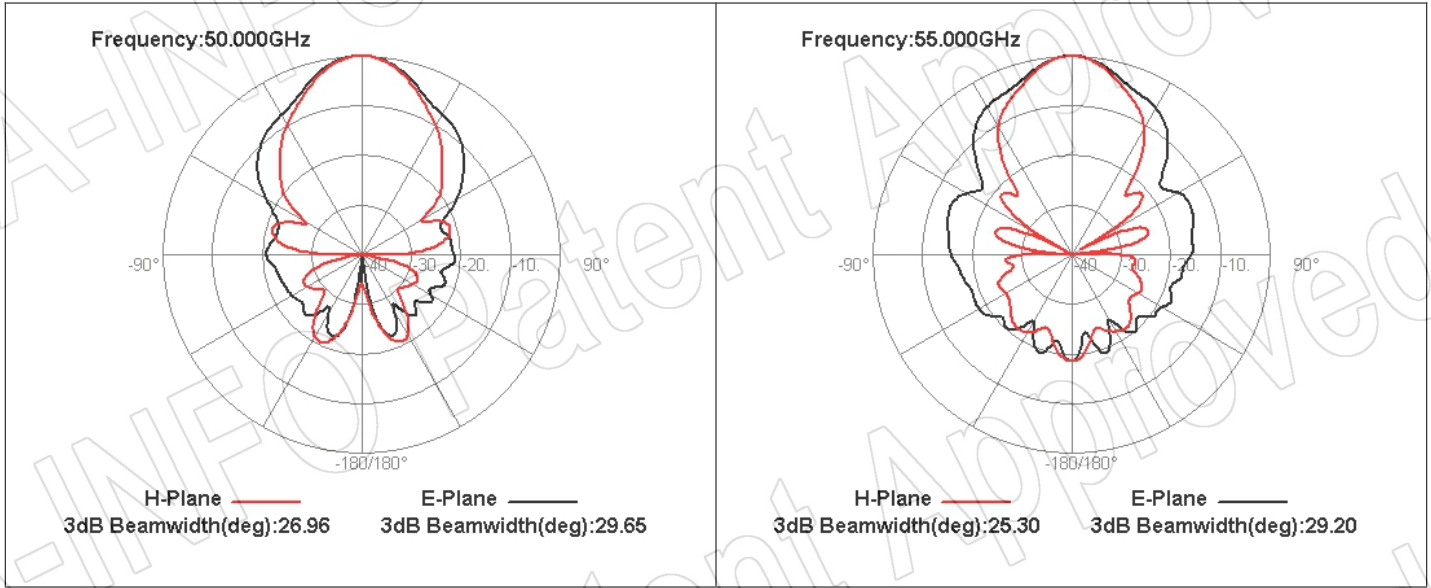

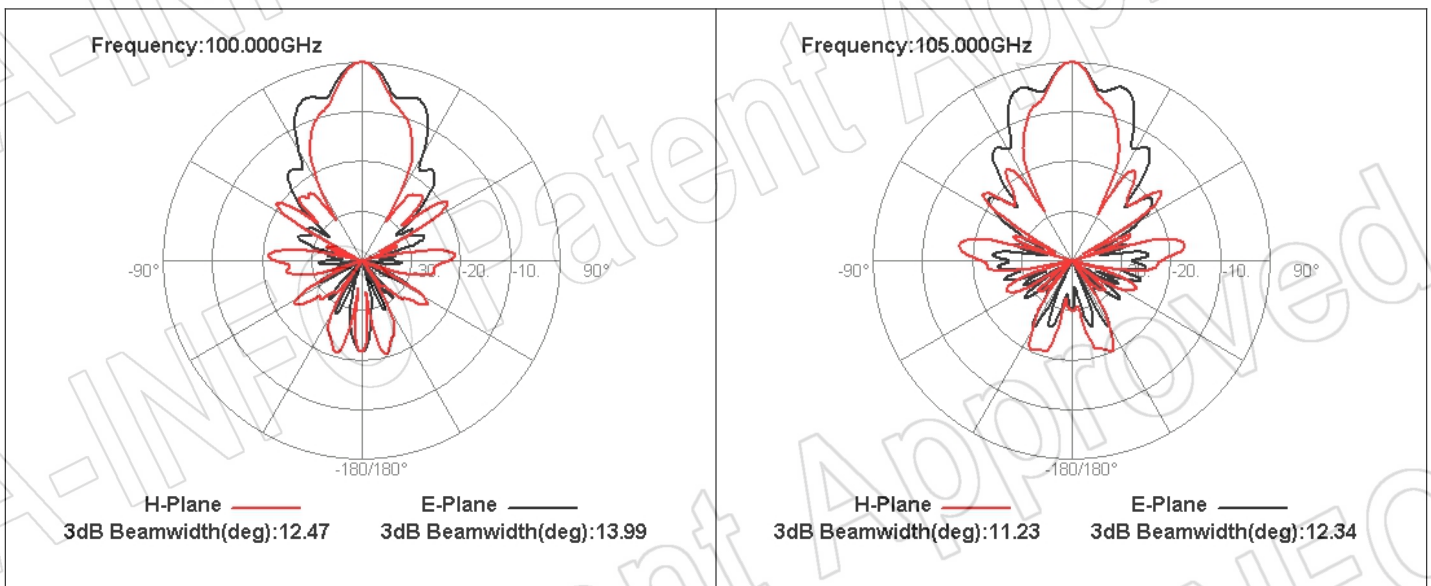
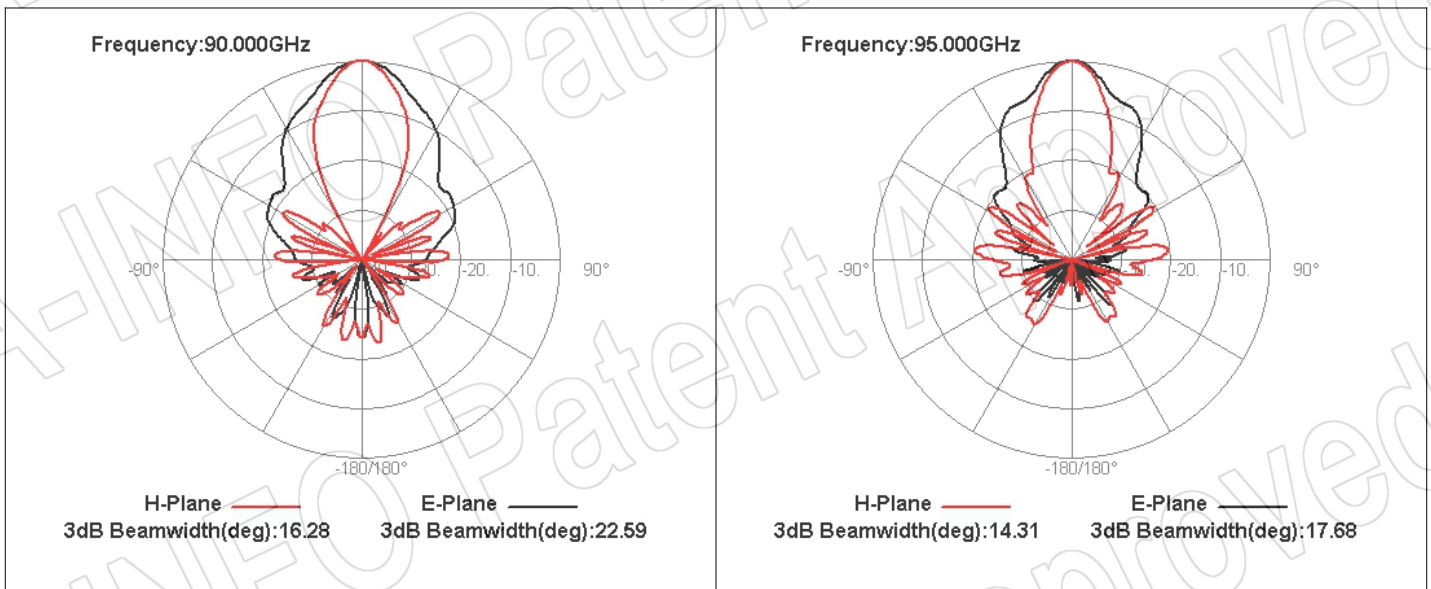
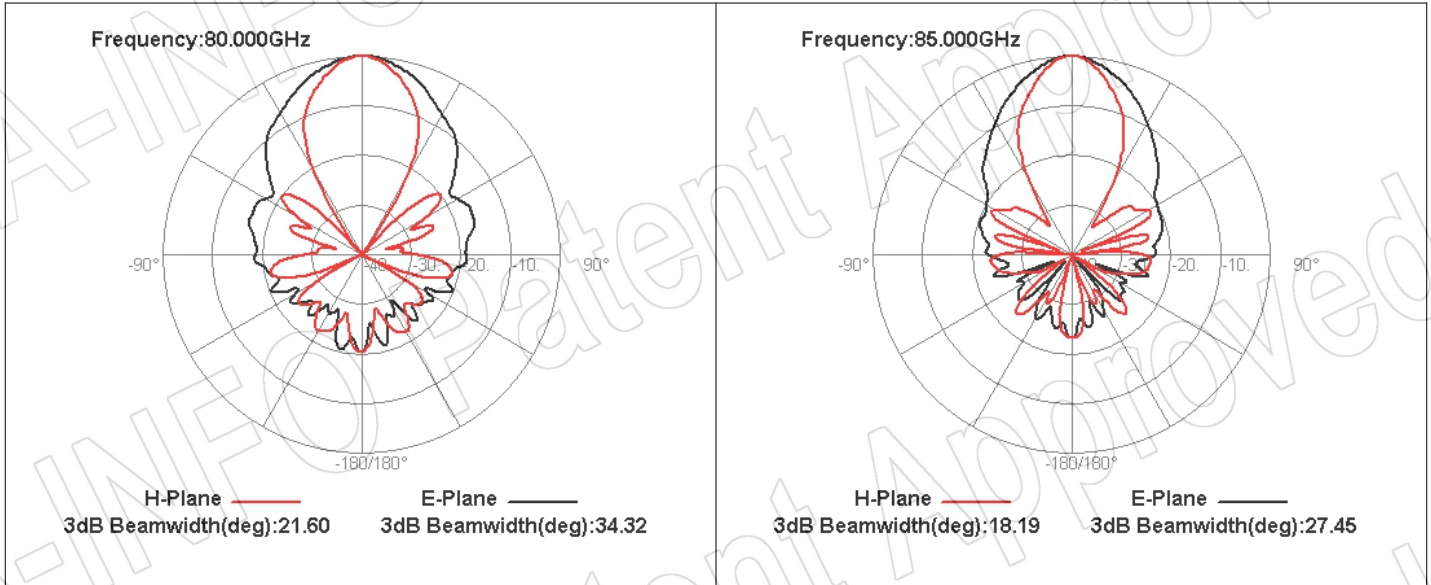

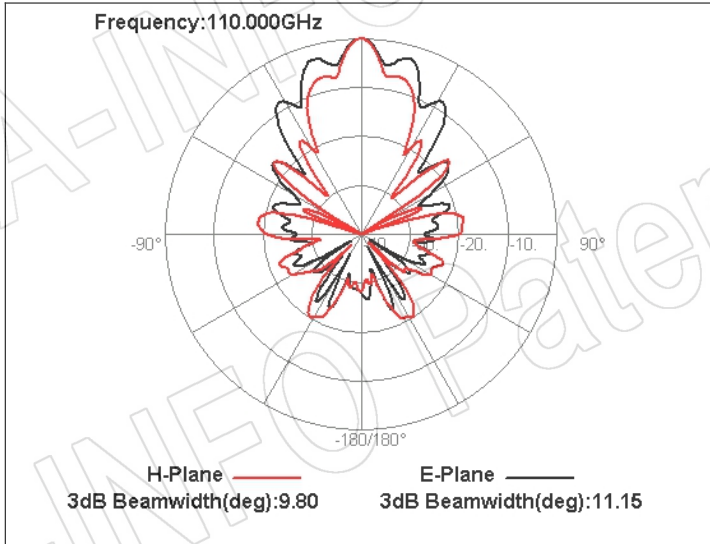

## AINFO Inc.

China(Beijing):  
China(Chengdu):  
USA :

Tel: (+86) 10-6266-7326,  
Tel: (+86) 28-8519-2786,  
Tel: (+1) 949-639-9688,

(+86) 10-6266-7327  
(+86) 28-8519-3044  
(+1) 949-639-9608

Fax: (+86) 10-6266-7379  
Fax: (+86) 28-8519-3068  
Fax: (+1) 949-639-9670

Website: [www.ainfoinc.com](http://www.ainfoinc.com)  
Email: [sales@ainfoinc.com](mailto:sales@ainfoinc.com)